

TECHNICAL DATA SHEET

PRODUCT	HYDROSTATIC TEST EQUIPMENT
MODEL	D1-515REX
SERIES	SERIE D1-REX
API	CERTIFIED ACCORDING TO API SPECIFICATIONS



Designed for all purpose: Low, medium and high pressure testing. Hydrostatic pressure testing on dully compact, affordable and mobil used on testing with water, hydraulic, glycol, chemicals and many other solubles. Most using in work shops, chemical plants, refineries and oil rigs. Air driven liquid pump.

D1-REX Series are used in most industries including Oil & Gas for: Pressure on Pipes, Valves, Hoses, Vessels, Spools, etc.

FEATURES/BENEFITS

- Designed for easy maintenance
- Low cost servicing
- Air operated liquid pumps
- All pressure valves, tubing, fittings & hardware are stainless 316
- Pressure Chart Recorder Port (Optional)
- Dolly heavy duty steel frame solid rubber tires
- Made with USA highest quality components
- Unit weight: 100 pounds / Dimensions: : 28"L x 48"H x 20"W
- HS Code: 8413.50.0050
- Certificated according to API specifications

PERFORMANCE DATA

Max. Output Flow	7.9 GPM (30 LPM)
Max Output Pressure	500 psi (35 bar)
Air Supply - Driven	60-110 Psi (scfm 24-56)
Air Inlet Port	1/2" female NPT
Inlet Liquid Port	1/2" female NPT
Outlet Pressure Port	1/2" female NPT
Pump Brand & Ration	SC-Hydraulic Ratio 5:1

FLOW CURVE RATIO 5:1

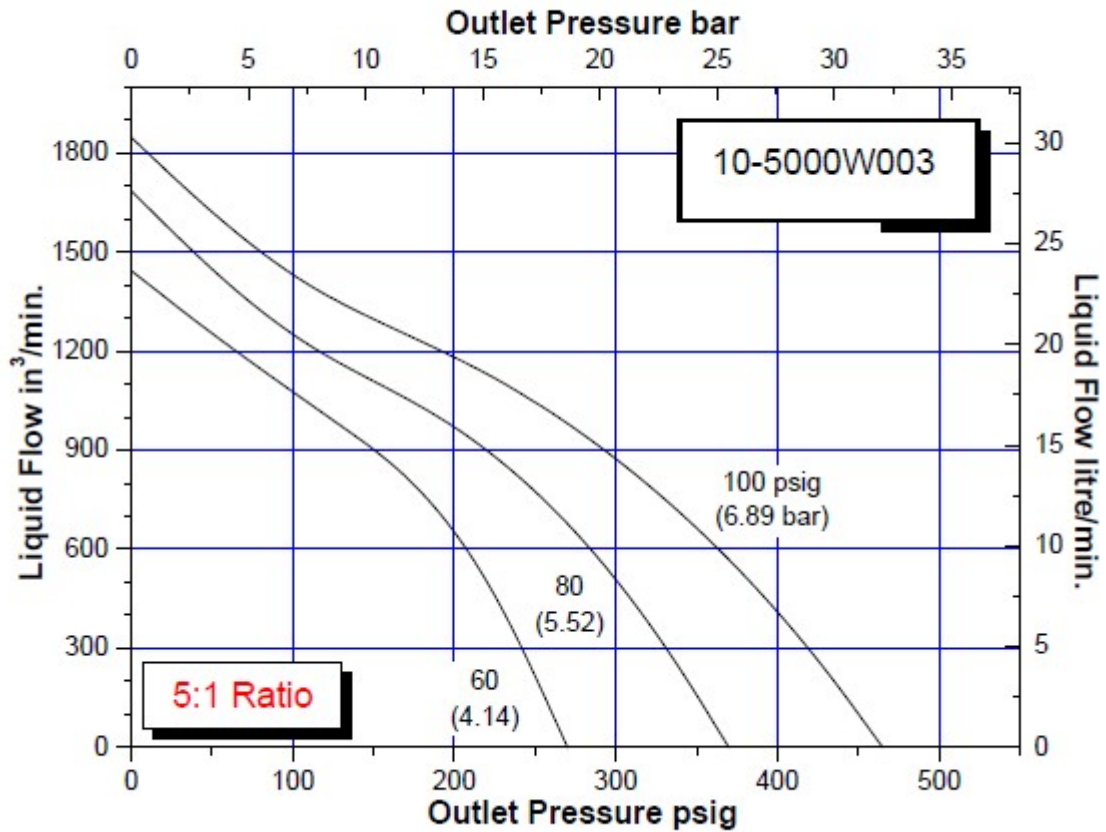

GENERAL PRODUCT INFORMATION

- When operating from 0 to rated hydraulic pressure, air consumption will be approximately **24-56 scfm** of free air at 100 psi output. At lower air pressures and higher hydraulic pressures air consumption will be reduced proportionately to flow rates indicated.
- The D1REX Series "Dry Lube" pump does not require an air line lubricator.
- Contact Hydrorex for pressure gauges calibration / certificate.
- Maintenance parts for future repairs, all components & accessories can be found on our website www.hydrorex.com.

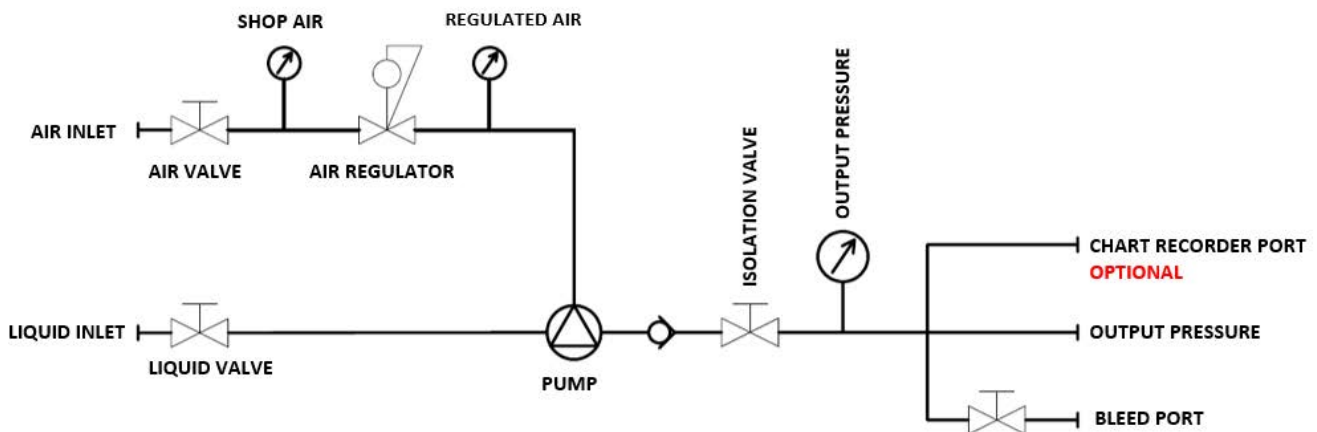

HYDROREX D1-REX Series

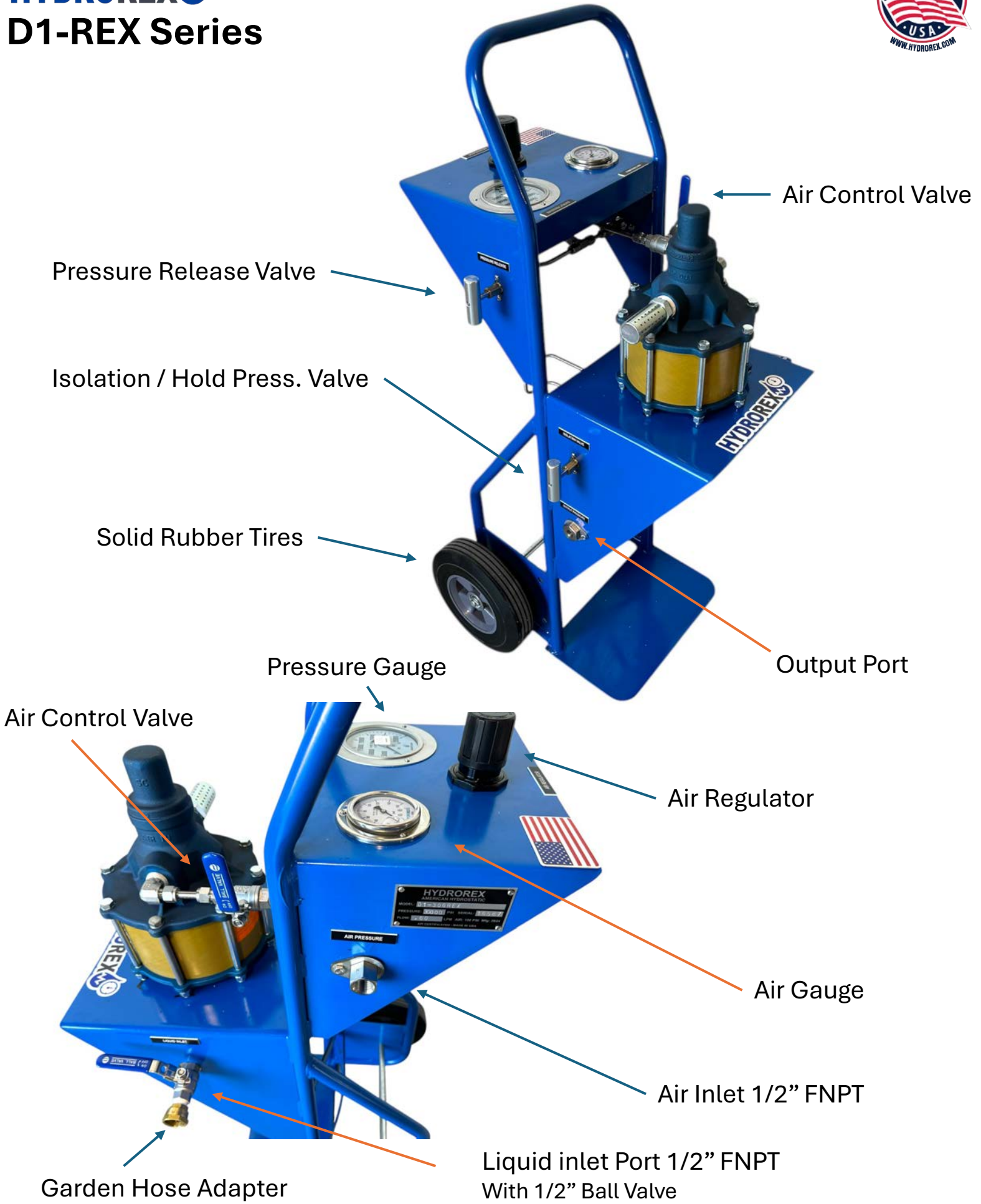

Air Control Valve

Pressure Release Valve

Isolation / Hold Press. Valve

Solid Rubber Tires

Output Port

Pressure Gauge

Air Control Valve

Air Regulator

Air Gauge

Air Inlet 1/2" FNPT

Garden Hose Adapter

Liquid inlet Port 1/2" FNPT
With 1/2" Ball Valve