

SE Hydraulic
Engineering

HYDROREX 



sales@hydrorex.com - eli@hydrorex.com
Office: 832 277 1182 - Mobil: 281 989 1216

13360 TELGE RD #606 CYPRESS TEXAS 77429 USA

10 REX SERIES

HYDROSTATIC UNIT

THE PROFESSIONAL STYLE



P
U
M
P
S

www.hydrorex.com
www.pressureshop.com

10 REX SERIES

"The Professional Style" is the most common standard testing equipment.

LOW, MEDIUM & HIGH PRESSURE: Is a pneumatic drive system, thirteen models are available with pressures up to 65,000 psig. ideal for testing in small confined spaces and remote locations. Designed for liquids pressure on all industries including Oil & Gas for use with any liquid such water, glycol, hydraulic, oils and more.

Made in USA with highest quality components for low operational cost.

When operating from 0 to rated hydraulic pressure, air consumption will be approximately 18-56 scfm of free air at 100 psi output. At lower air pressures and higher hydraulic pressures air consumption will be reduced proportionately to flow rates indicated.

The 10-REX Series "Dry Lube" pump does not require an air line lubricator

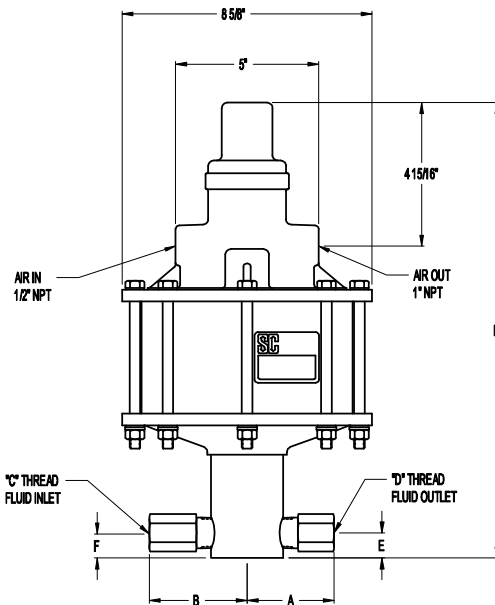

For pressure, flow rates and ports size for each model, please download the model datasheet below the product on the web www.hydrorex.com

Components: USA Brands, Parker, Swagelok, SC Hydraulic, Mc Daniels

- Structure: Heavy duty 1" Square tubing carbon steel
- Stainless Steel control plates
- All Stainless steel, valves, tubing, fittings & hardware
- Requires 80 – 100 psi air pressure to operate

Dimensions: 22" Length, 18" High, 14" Width
Weight: 70 Lbs
Shipping Wood Crate Dimensions: 24"L x 20" H x 18" W
Shipping Weight: 80 Lbs
HS Code: 8413.50.50.00



Measurements & Approximate Air to Hydraulic Pressure

| Pressure Ratio | 10 Series Model | Hydraulic Piston Diameter (in) | Hydraulic Piston Area (in ²) | Volume per Stroke (in ³) | Air Pressure (PSI) | | | | | | | | | |
|----------------|-----------------|--------------------------------|--|--------------------------------------|--------------------|-------|-------|-------|-------|-------|-------|-------|-------|-------|
| | | | | | 10 | 20 | 30 | 40 | 50 | 60 | 70 | 80 | 90 | 100 |
| 5 | 10-515 | 2.3 | 4.430 | 5.540 | 30 | 75 | 130 | 175 | 220 | 320 | 370 | 410 | 460 | 500 |
| 5 | 10-530 | 3.00 | 7.070 | 17.70 | 50 | 100 | 150 | 200 | 250 | 300 | 350 | 400 | 450 | 500 |
| 10 | 10-1012 | 2.125 | 3.560 | 8.900 | 85 | 185 | 285 | 390 | 490 | 590 | 690 | 795 | 900 | 1000 |
| 20 | 10-219 | 1.438 | 1.620 | 4.050 | 165 | 425 | 650 | 875 | 1075 | 1300 | 1550 | 1750 | 1950 | 2150 |
| 25 | 10-277 | 1.315 | 1.350 | 3.380 | 180 | 450 | 725 | 1000 | 1300 | 1550 | 1850 | 2125 | 2400 | 2700 |
| 35 | 10-365 | 1.125 | 0.994 | 2.490 | 250 | 625 | 1025 | 1400 | 1800 | 2150 | 2500 | 2850 | 3250 | 3600 |
| 55 | 10-603 | 0.875 | 0.601 | 1.500 | 450 | 1050 | 1700 | 2275 | 2900 | 3500 | 4100 | 4650 | 5200 | 6000 |
| 95 | 10-982 | 0.688 | 0.371 | 0.928 | 750 | 1750 | 2800 | 3700 | 4750 | 5900 | 6875 | 7700 | 8750 | 9700 |
| 145 | 10-151 | 0.563 | 0.249 | 0.623 | 1100 | 2600 | 4200 | 5550 | 7100 | 8500 | 10000 | 11500 | 12950 | 14400 |
| 180 | 10-181 | 0.500 | 0.196 | 0.490 | 1500 | 3200 | 5200 | 7100 | 9000 | 10800 | 12500 | 14500 | 16300 | 18000 |
| 240 | 10-201 | 0.438 | 0.150 | 0.375 | 1900 | 4400 | 6900 | 9100 | 11600 | 14000 | 15400 | 17800 | 19300 | 20000 |
| 240 | 10-241 | 0.438 | 0.150 | 0.375 | 1900 | 4400 | 6900 | 9100 | 11600 | 14000 | 16400 | 18800 | 21300 | 23700 |
| 330 ** | 10-326 ** | 0.375 | 0.110 | 0.275 | 3000 | 6000 | 9500 | 12600 | 16000 | 19100 | 22300 | 25600 | 29000 | 32300 |
| 460 ** | 10-454 ** | 0.313 | 0.077 | 0.193 | 4000 | 8800 | 13700 | 18000 | 22500 | 27000 | 31500 | 36500 | 41400 | 45800 |
| 740 ** | 10-652 ** | 0.250 | 0.049 | 0.123 | 8000 | 15000 | 23000 | 29700 | 37200 | 45000 | 52500 | 59200 | 66500 | *** |

10-REX Series



Additional Pressure Port on Top
Could be used for: Chart Recorder, Sensor, Extra Output, or Extra Pressure Gauge
NEED TO BE REQUESTED

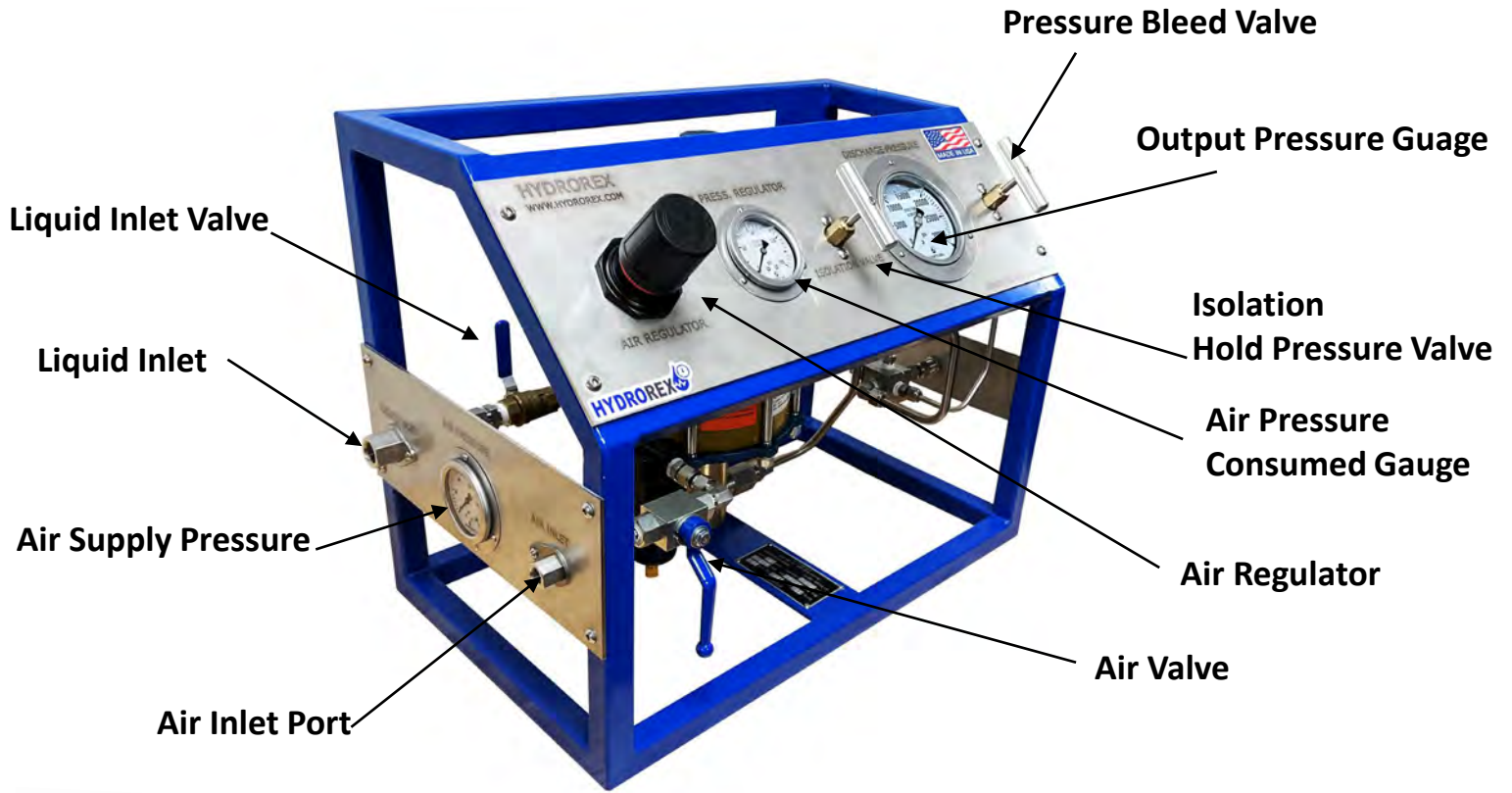

Output Pressure **Bled Pressure**



Liquid Inlet **Air Supply Press.**
Air Inlet

MANUFACTURER'S OPERATING INSTRUCTIONS

SERIES **• Serie 10REX**

PNEUMATIC HYDROSTATIC TEST PUMPS

Prior to testing any high pressure line, please check all connections, hoses and fittings to assure that they are properly tightened and in good working order. No frays, tears, or cuts.
REQUIRED: Air compressor capable of 60-100 PSI.

Liquids: Water, Hydraulic, Oils, Glycol and many more.



CONNECTING THE PUMP

1. Connect your output pressure hose. Position the Test Pump within 8 feet of test environment.
2. Connect the air line from your shop compressor to the inlet port on the unit.

NOTE: AIR FILTER SHOULD BE DRAINED OF ANY WATER OR DIRT PARTICLES BEFORE, AND AFTER USE. Drain valve is located on the bottom of the filter body. (this filter is located inside the unit at the air inlet port)

OPERATING THE PUMP

1. Open your liquid inlet ball valve
2. Open the release/bleed valve on the control panel or in your test line to bleed off excess air.
3. Start your air shop compressor.
4. Once the compressor has reached operating pressure 100 psi (This will give maximum operating output) open the air ball valve slowly, which will allow the air to flow to the regulator. (located at the bottom of the control panel)
5. Adjust the air regulator, Pull up on the black knob and turn clockwise to increase pressure, or counter-clockwise to decrease pressure. Once the inlet air pressure is set, push down on the knob to lock it in place.
6. Start turning regulator clockwise, pressure will begin building as soon as air flows.
When desired test pressure has been met, close the outlet needle valve to isolate test environment.
To turn off pump while testing, turn regulator counter clockwise and decrease or stop air flow, or disconnect air compressor supply. If a pressure drop is indicated, check the following:

- a. Output hose connection at pump.
- b. Output hose connection at test line.
- c. Leaking test line or air in the test environment.

7. When you are done with the hydrostatic pressure test run, release the pressure open slowly the needle valve on control plate (bleed/return).

If the pressure gauge remains constant, turn off air ball valve and monitor gauge for your prescribed test time. When test is complete, open the high pressure return/bleeder valve located on control panel, Bleed off the liquid pressure. Repeat the above steps for multiple lines. Be sure the air pressure gauge reads zero before disconnecting the air line from the pump.



10 REX SERIES

APPROXIMATE RATE OF DISCHARGE

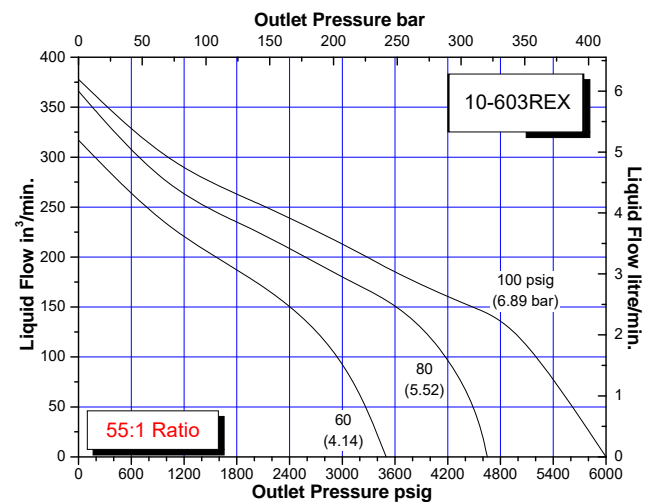
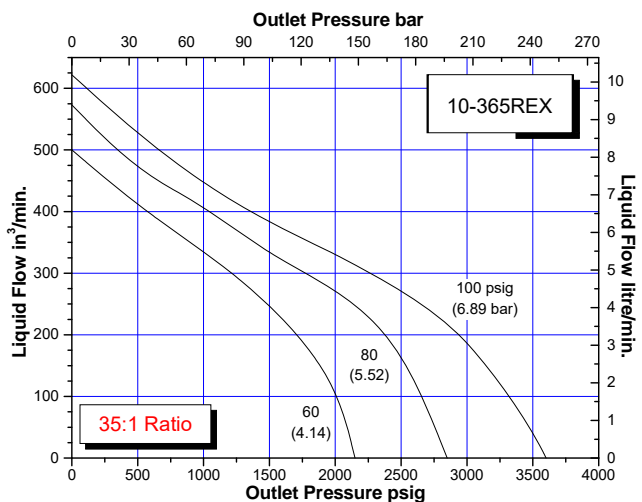
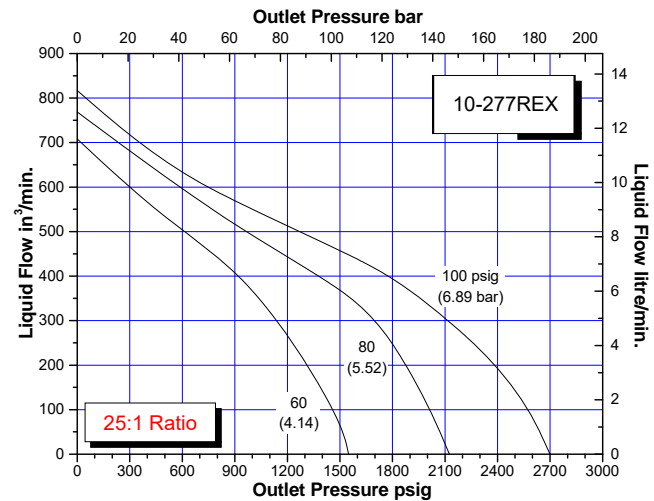
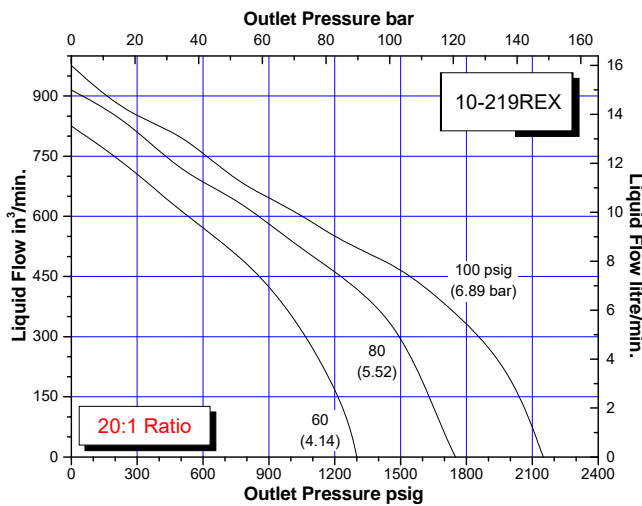
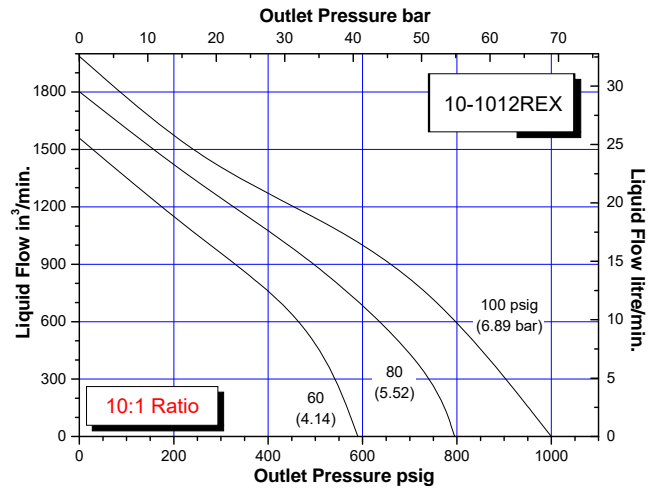
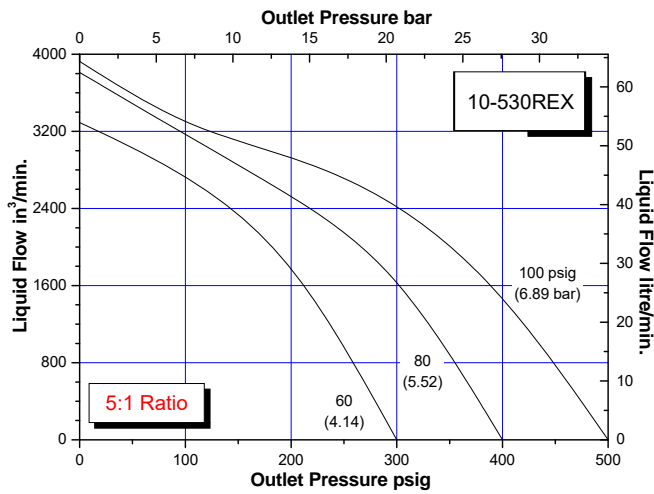

10 REX SERIES

APPROXIMATE RATE OF DISCHARGE

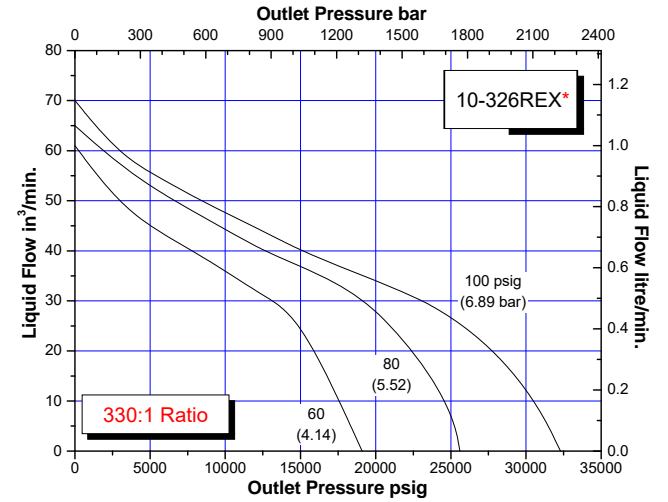
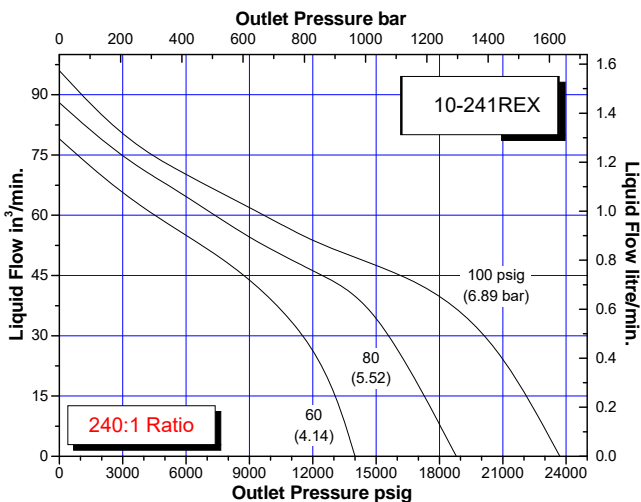
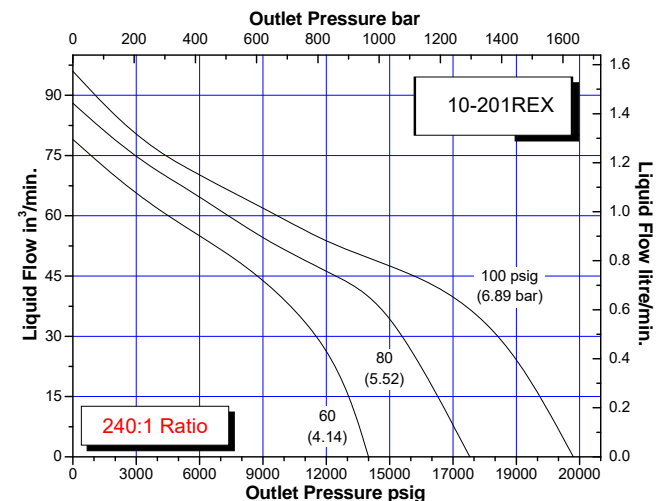
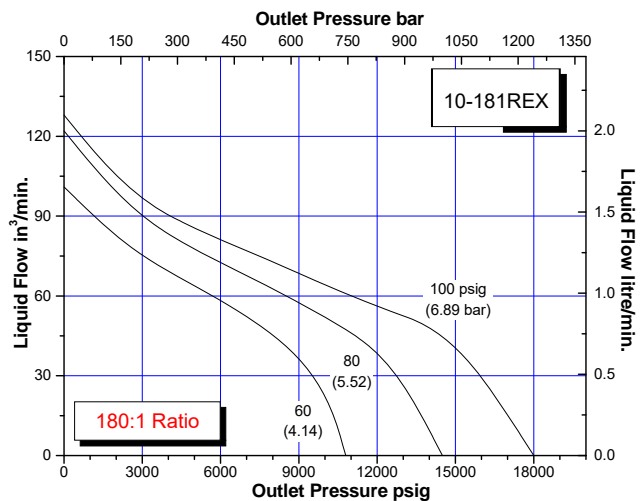
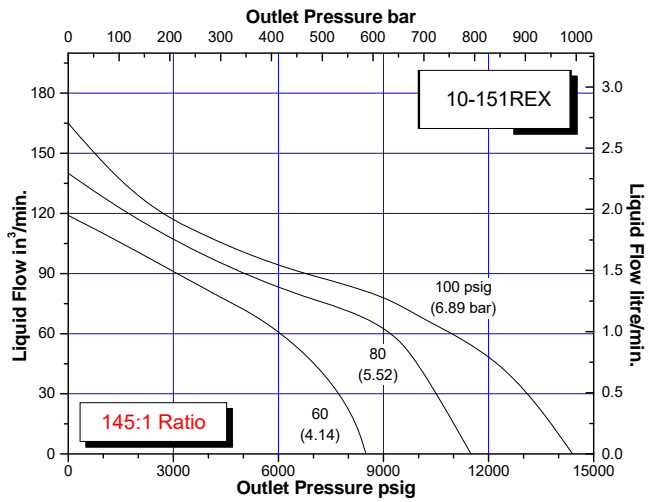
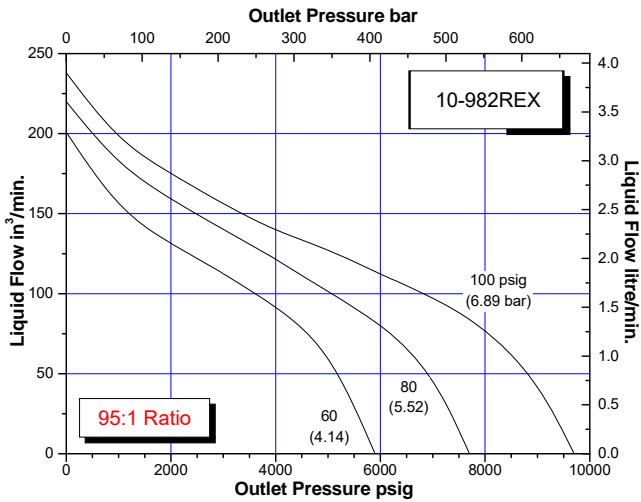

10 REX SERIES

APPROXIMATE RATE OF DISCHARGE

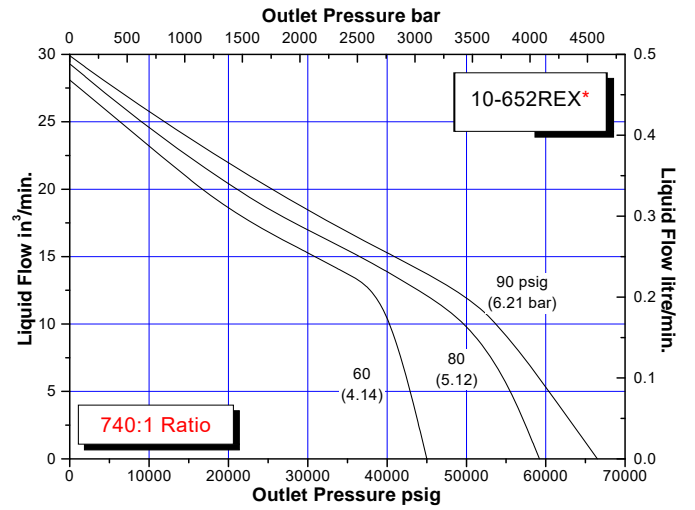
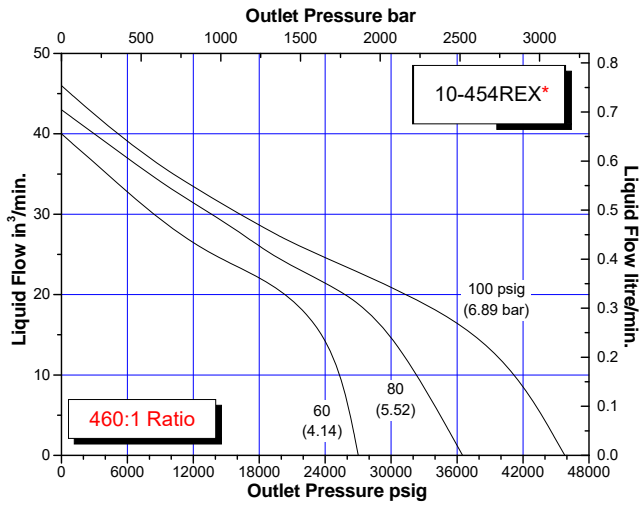

Liquid Pump Cut-a-way

